

Warm



Design by Ramos & Bassols.

Offering a contemporary take on a timeless design, Warm features a generously sized, classic drum shade suspended from nearly invisible clear cords, with a careful selected color palette that provides a contemporary touch.



Offering a contemporary take on a timeless design, Warm features a classic drum shade suspended from nearly invisible clear cords. The generously sized pendant is available with compact fluorescent or LED light sources. It's offered in two shade types: a screen or aluminum shade, both of which provide general ambient illumination.

Screen shade: Ref. 4925, 4930, 4935.

● 10 White (NCS S 0300-N)

Aluminum shade: Ref. 4926.

● 10 White (NCS S 0300-N)

● 25 Beige D1 (NCS S 4005-Y50R)

● 28 Brown M1 (NCS S 4020-Y60R)

● 56 Green D1 (NCS S 7010-G30Y)

Diffuser: Methacrylate.

Shade: Screen / Aluminum.

Canopy: Steel.

Ref. 4925.

LED bulb.

Ref. 4926, 4930, 4935.

LED bulb or compact fluorescent.

Personalization options available

Ref. 4926.

- Finish customization

(Available options: Vibia color palette)

- Extra cable length

Request more information.

4925 4926

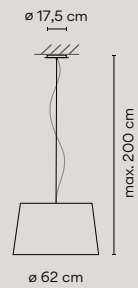

4930

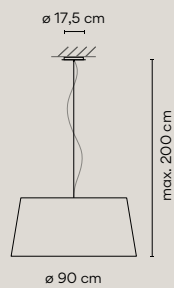

4935

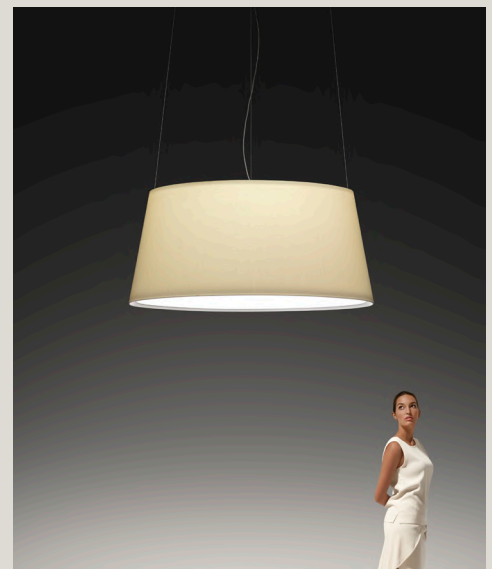
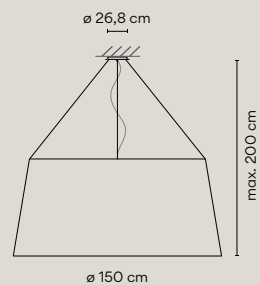

Pg 118



Pg 198



Pg 230



Warm

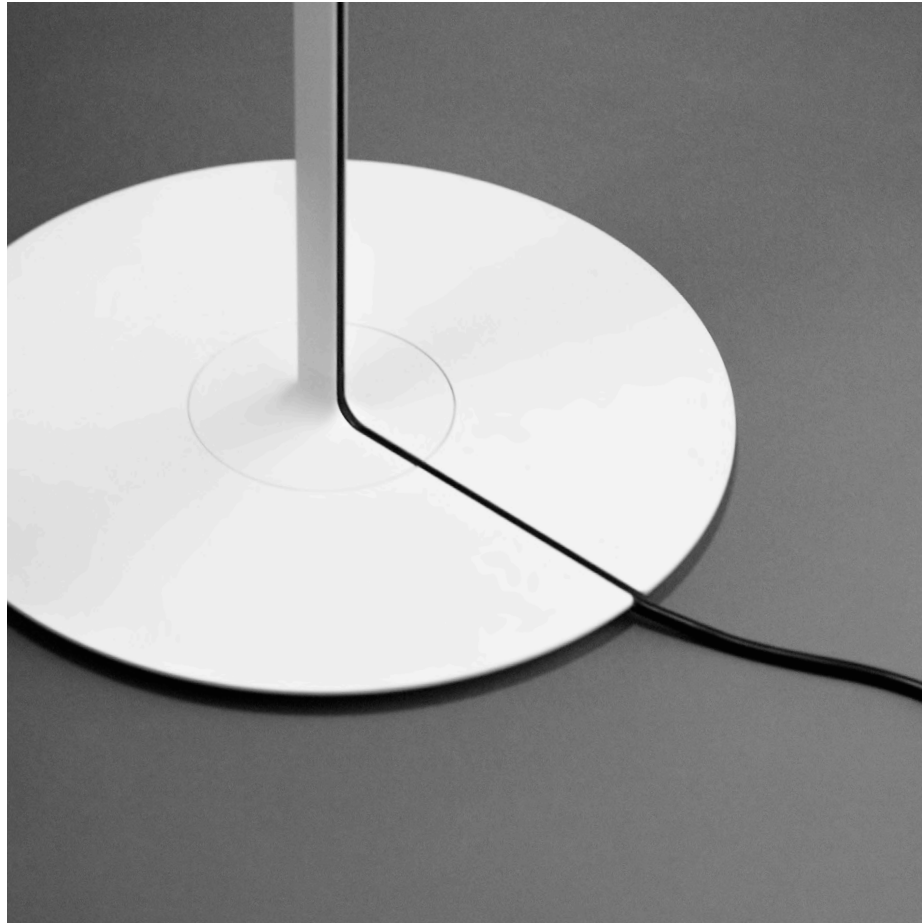

Design by Ramos & Bassols.

Offering a contemporary take on a timeless design, Warm features a classic drum shade resting atop a sleek steel column, with a careful selected color palette that provides a contemporary touch.







Offering a contemporary take on a timeless design, Warm features a classic drum shade resting atop a sleek steel column, with a careful selected color palette that provides a contemporary touch. The floor lamp comes with compact fluorescent or LED light source. It's available in either a screen or aluminum shade, both of which provide general ambient illumination.

Screen shade: Ref. 4905.

● 10 White (NCS S 0300-N)

Aluminum shade: Ref. 4906.

● 10 White (NCS S 0300-N)

● 25 Beige D1 (NCS S 4005-Y50R)

● 28 Brown M1 (NCS S 4020-Y60R)

● 56 Green D1 (NCS S 7010-G30Y)

Diffuser: Methacrylate.

Base: Steel.

Vertical tube: Aluminum.

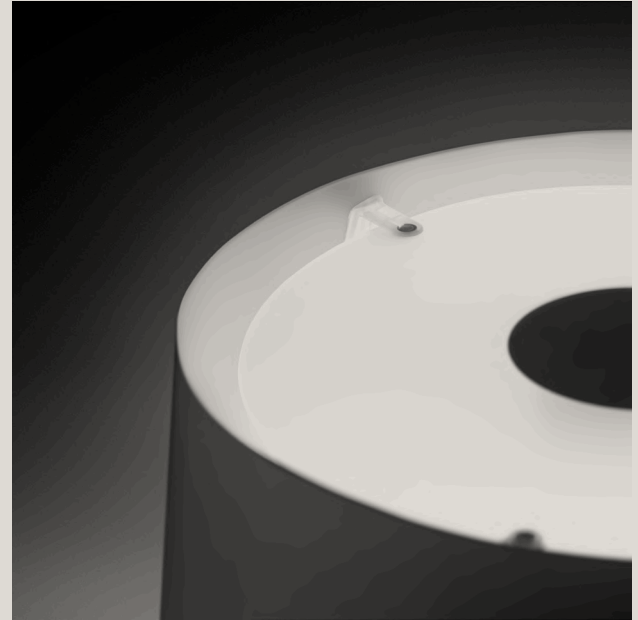

Ref. 4905.

LED bulb.

Ref. 4906.

LED bulb or compact fluorescent.

On/off switch on the cable.

Personalization options available

Ref. 4906.

- Finish customization

(Available options: Vibia color palette)

Request more information.



Pg 118



Pg 198



Pg 230



4905 4906



Warm

Design by Ramos & Bassols.

Offering a contemporary take on a timeless design, Warm features a classic drum form resting atop a sleek steel base, with a careful selected color palette that provides a refined touch.

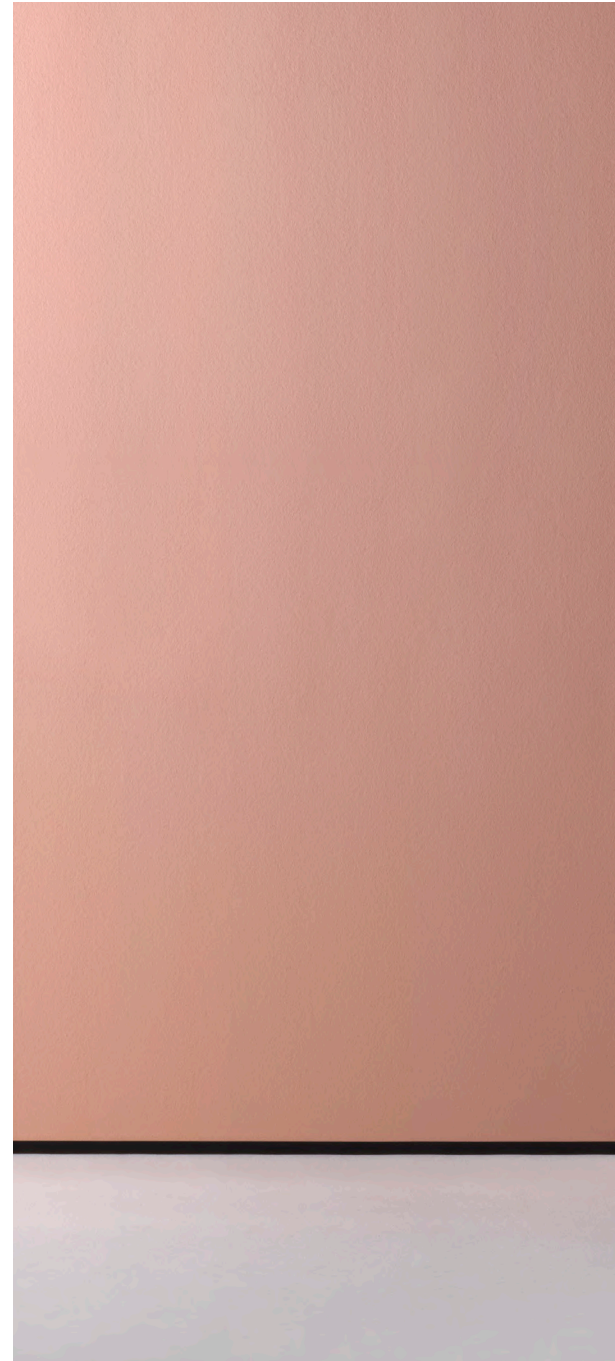







Offering a contemporary take on a timeless design, Warm features a classic drum form resting atop a sleek steel base. The LED-powered table lamp is available in two shade types: the translucent screen version provides general ambient illumination, while the opaque aluminum shade offers a brighter, up- and down-light.

Screen shade: Ref. 4895, 4900.

● 10 White (NCS S 0300-N)

Aluminum shade: Ref. 4896 4901.

● 10 White (NCS S 0300-N)

● 25 Beige D1 (NCS S 4005-Y50R)

● 28 Brown M1 (NCS S 4020-Y60R)

● 56 Green D1 (NCS S 7010-G30Y)

Diffuser: Methacrylate.

Base: Steel.

Vertical tube: Aluminum.

Ref. 4895, 4896, 4900.
LED bulb.

Ref. 4901.
LED bulb or compact fluorescent.

On/off switch on the cable.

Personalization options available

Ref. 4896, 4901.

- Finish customization

(Available options: Vibia color palette)

Request more information.

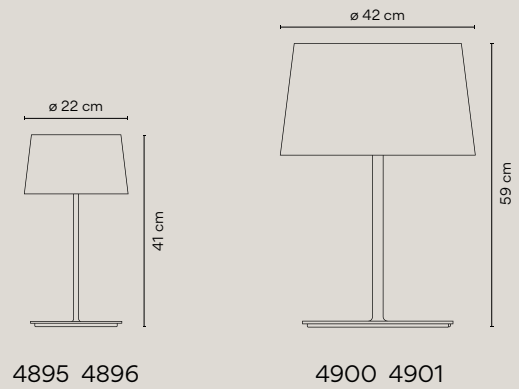

Pg 118



Pg 198



Pg 230

